

SECTION A-A

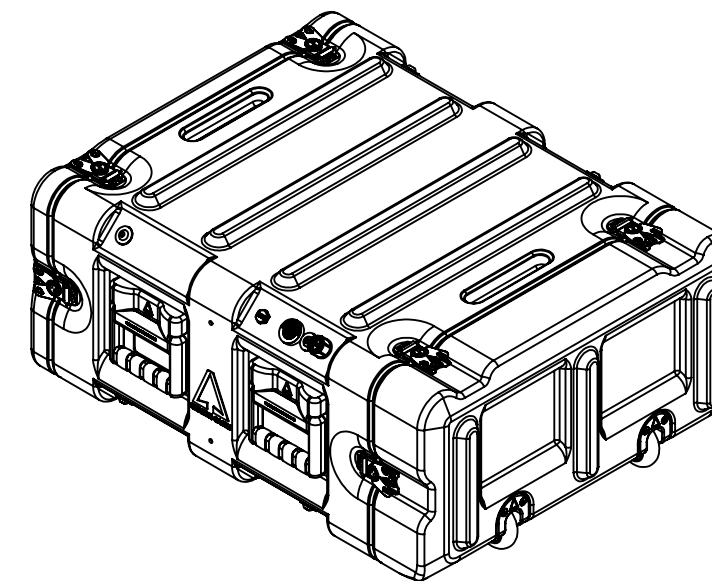

DETAIL B
SCALE 1 : 5

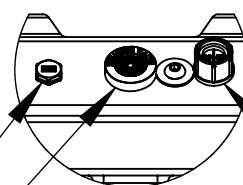

PRV Option Gore Membrane Vent PRV Option AGM Breather Valve PRV Option Humidity Indicator

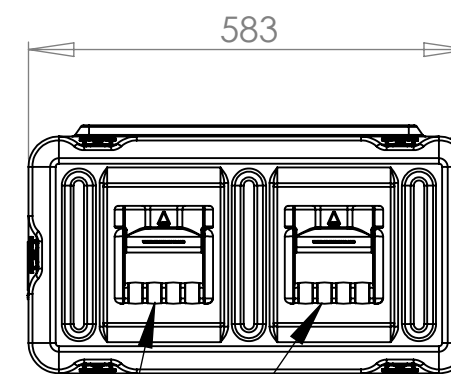
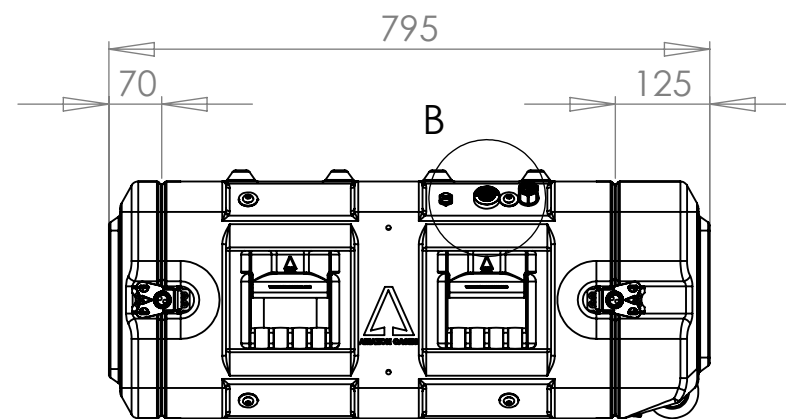
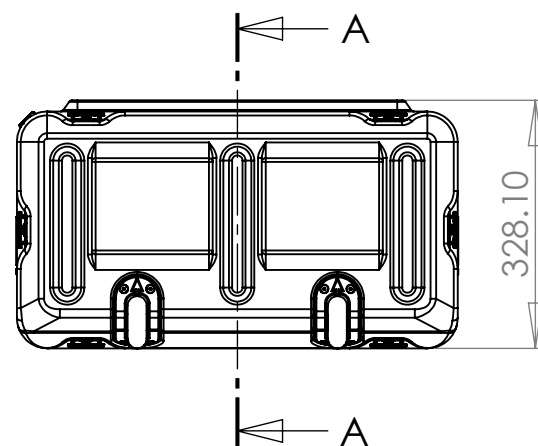
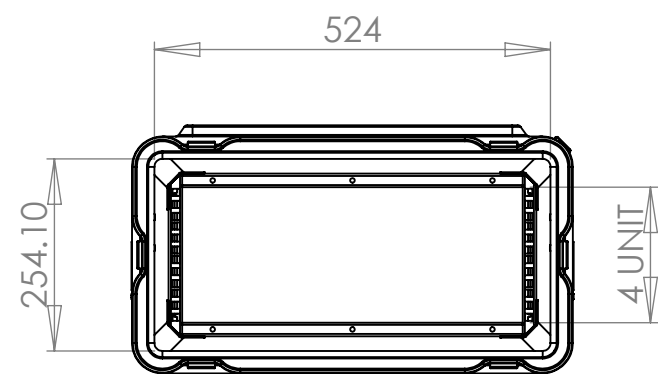

Handles on front lid are included with wheel option.

Options Available	Option Selected	Qty	Part #
Wheel Kit <small>includes two extra handles</small>	Y	01	AAW002
AGM Breather Valve	Y	01	AAPRV
Gore Membrane Vent	Y	01	AAGTV
Humidity Indicator	Y	01	AAHI
Tie Down Anchor	N	00	AATD001
Padlockable Latch	N	00	AALPLBK
Linking Straps	N	00	AASSBLRS
Cable Stowage Pouch	N	00	AASP****
Easy-Glide	N	00	AAEGS**
Support Shelf	N	00	AASS**
Latch	Y	12	AALBK
Plastic Handles	Y	06	AAHPL

Nato Stock No (NSN)		
8145-99-858-1856		
Moulding Tolerance +/- (1%+1mm)		
External Dimensions (mm)		
Height	Width	Depth
328	583	795
Rack Size (U)		04
Frame Depth (mm)		480

Title				Drg. No.	
Amazon Rack AR0448-0712				AR0448-0712	
Drawn By	Date	Sheet No.	Issue No.		
MW	09/07/2010	1 Of 1	02		
Dimensions In Millimeters			Third Angle Projection		
Do Not Scale					

CP Cases Ltd.

Worton Hall Industrial Estate, Worton Road,
Isleworth, Middlesex, TW7 6ER, UK.
Tel: +44 (0) 20 8568 1881 Fax: +44 (0) 20 8568 1141
Email: amazon@cpcases.com Website: www.cpcases.com

Copyright CP Cases Limited.
This drawing is the property of CP Cases Limited & the information on it is confidential & it is not to be used for any other purpose without the prior written consent of CP Cases Limited.