

NOTE:
ALL CATCH LIFT OFF LID.

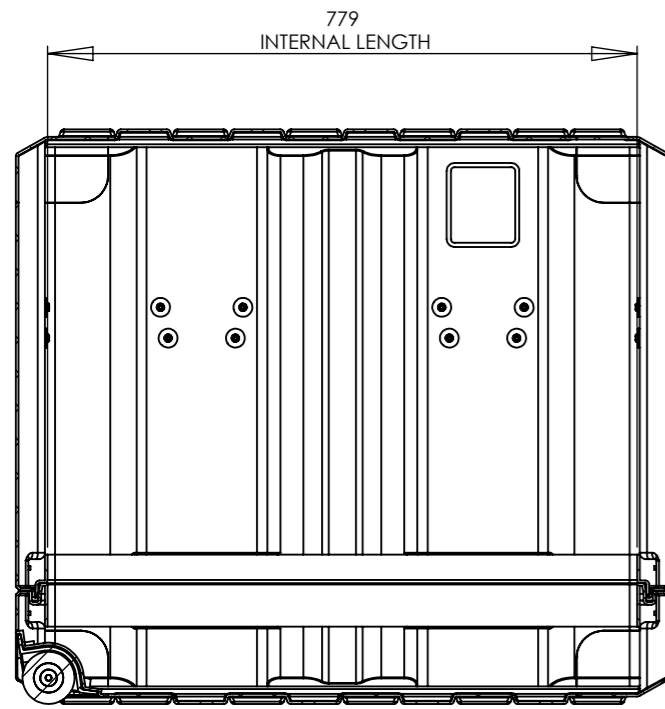

SECTION Y-Y
SCALE 1 : 10

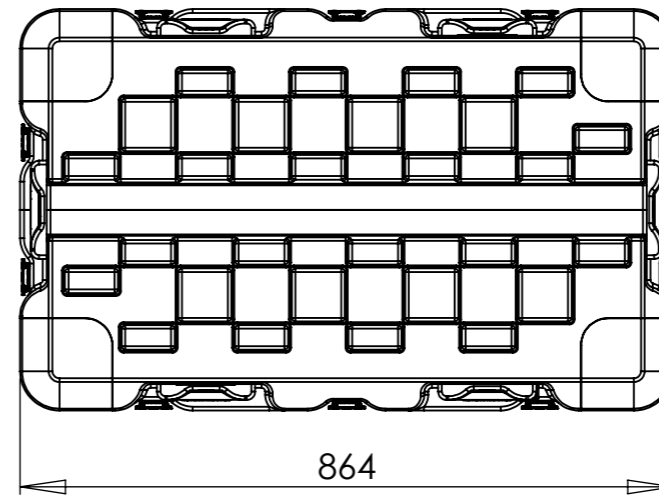
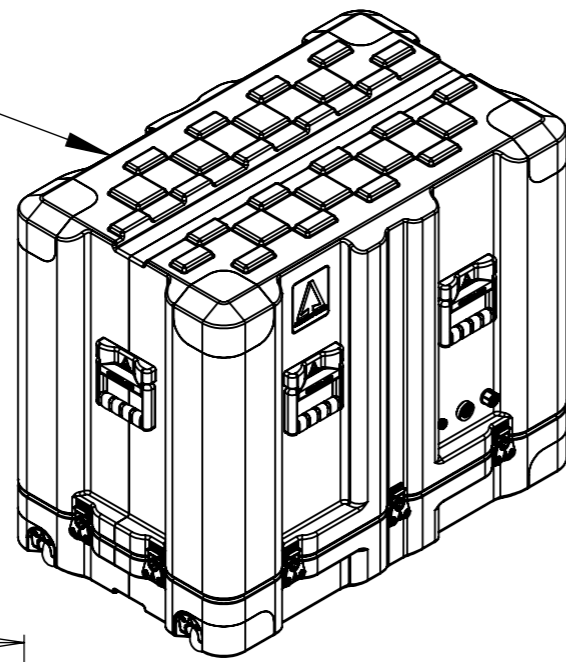
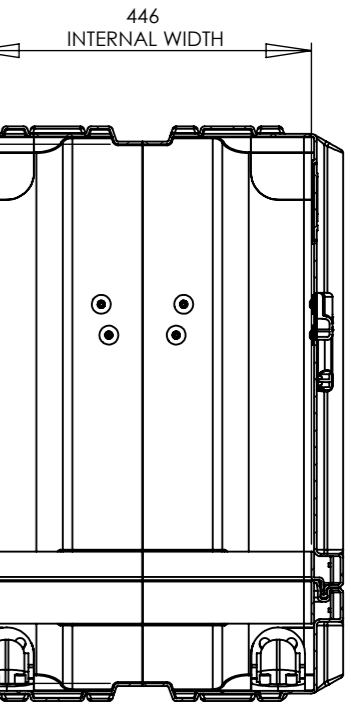
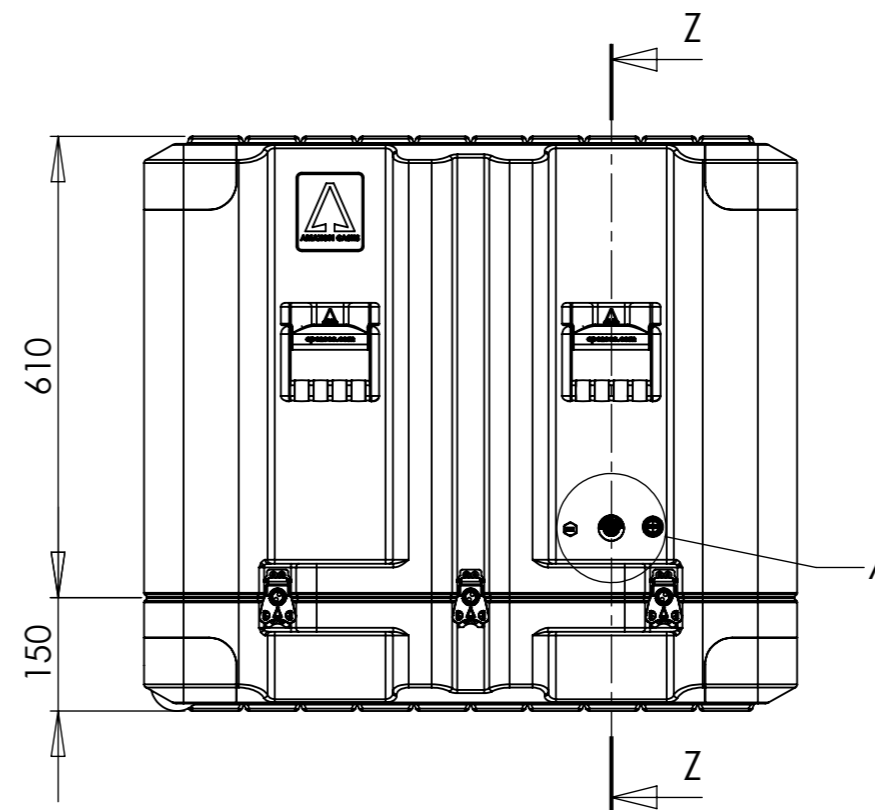
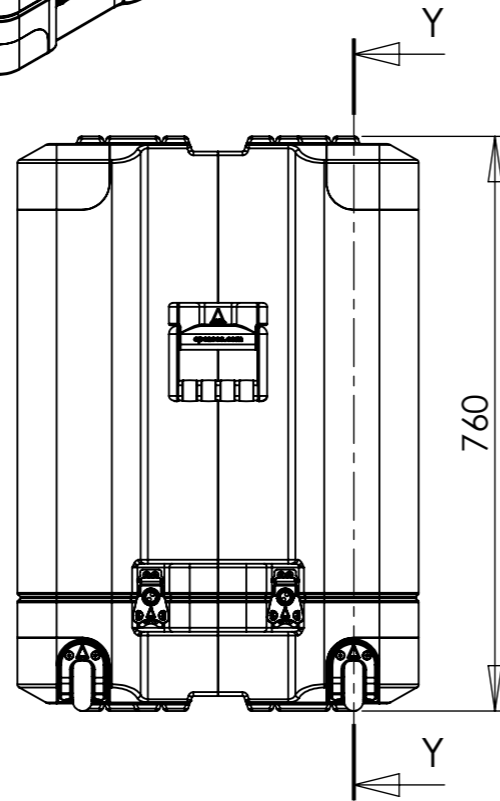

SECTION Z-Z
SCALE 1 : 10

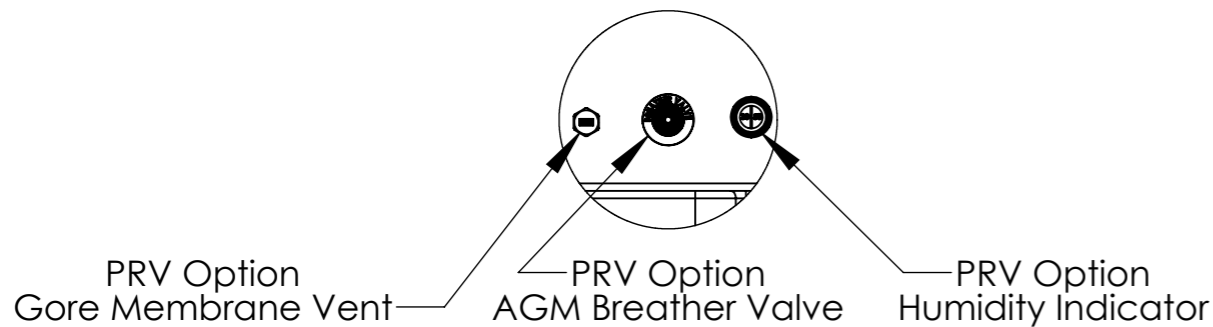
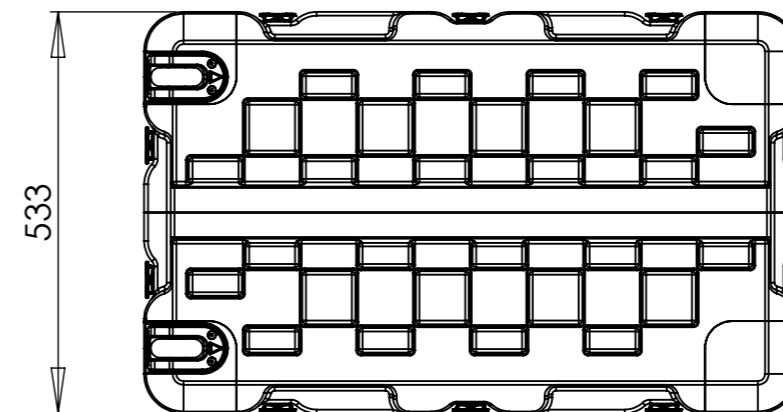

DETAIL A
SCALE 1 : 5

Title Amazon Case AC8754-1561/AC		Material Polyethylene		Finish Self Colour		Date 23/06/2010	Drawn By MW	Revision A	Project Amazon		CP Cases Ltd. Worton Hall Industrial Estate, Worton Road, Isleworth, Middlesex, TW7 6ER, UK. Tel: +44 (0) 20 8568 1881 Fax: +44 (0) 20 8568 1141 Email: info@cpcases.com Website: www.cpcases.com
Drg. No. AC8754-1561_AC		External Dimensions Height Width Length/Depth 760 533 864		Internal Dimensions Height Width Length/Depth 700 446 779		W/O No. 000000	Qty. 00	Sheet No. 1 Of 2	Nato Stock No. 8145-99-585-8854		
						Dimensions In Millimeters. Do Not Scale. Third Angle Projection.			Tolerance Unless Stated Otherwise. Moulding Tolerance +/- (1%+1mm). Sheet Metal Tolerance +/-0.5mm.		<small>Copyright CP Cases Ltd. This drawing is the property of CP Cases Ltd & the information on it is confidential. It is not to be used for any other purpose without the prior written consent of CP Cases Ltd.</small>