

C-C

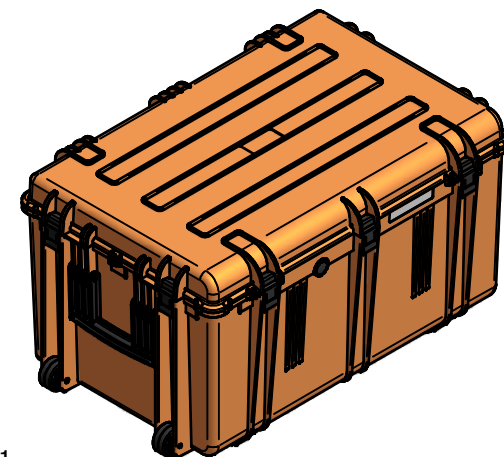

B-B

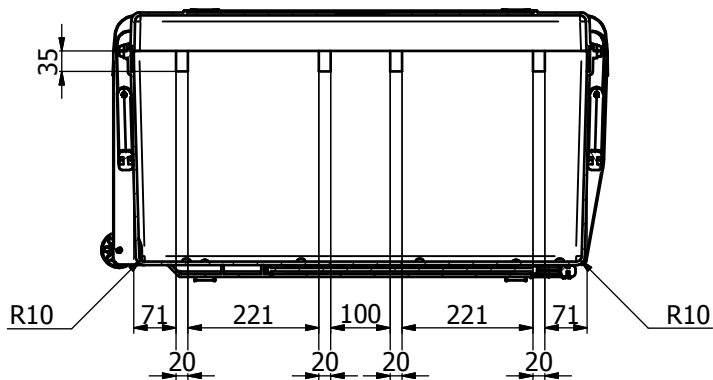
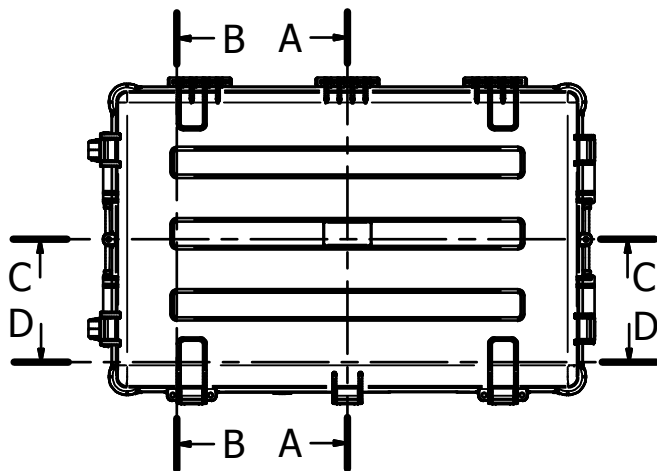
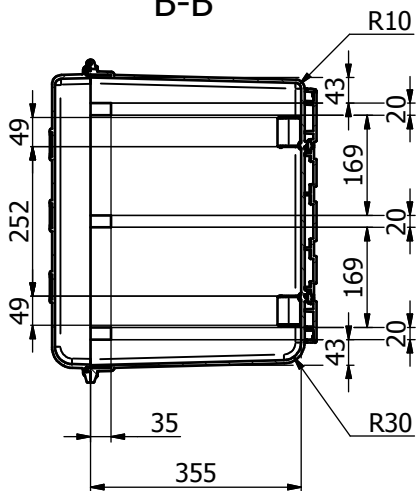

A-A

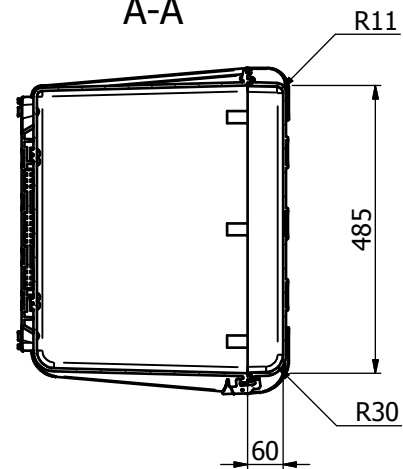

D-D

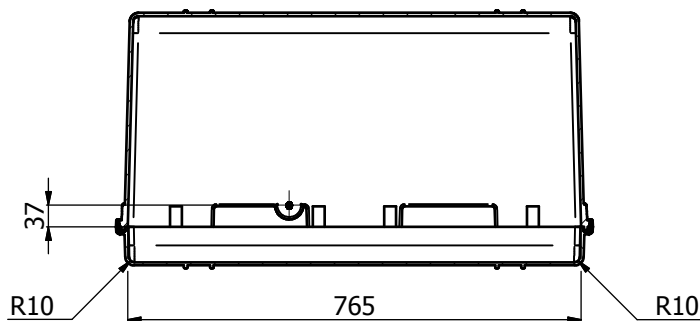

EXPLORER CASES
Internal dimension-general tolerance +/-1.5%
GT Line - TechDept - All rights reserved

Note		Scale	Size	General Clearance
ALL DIMENSIONS IN mm			A3	
Material		Treatment		Color
Designer	Date	Check	Date	Replace by
	23/05/2012			
Description		Date		
		File Name		Revision
		7641		